

2013.07.15

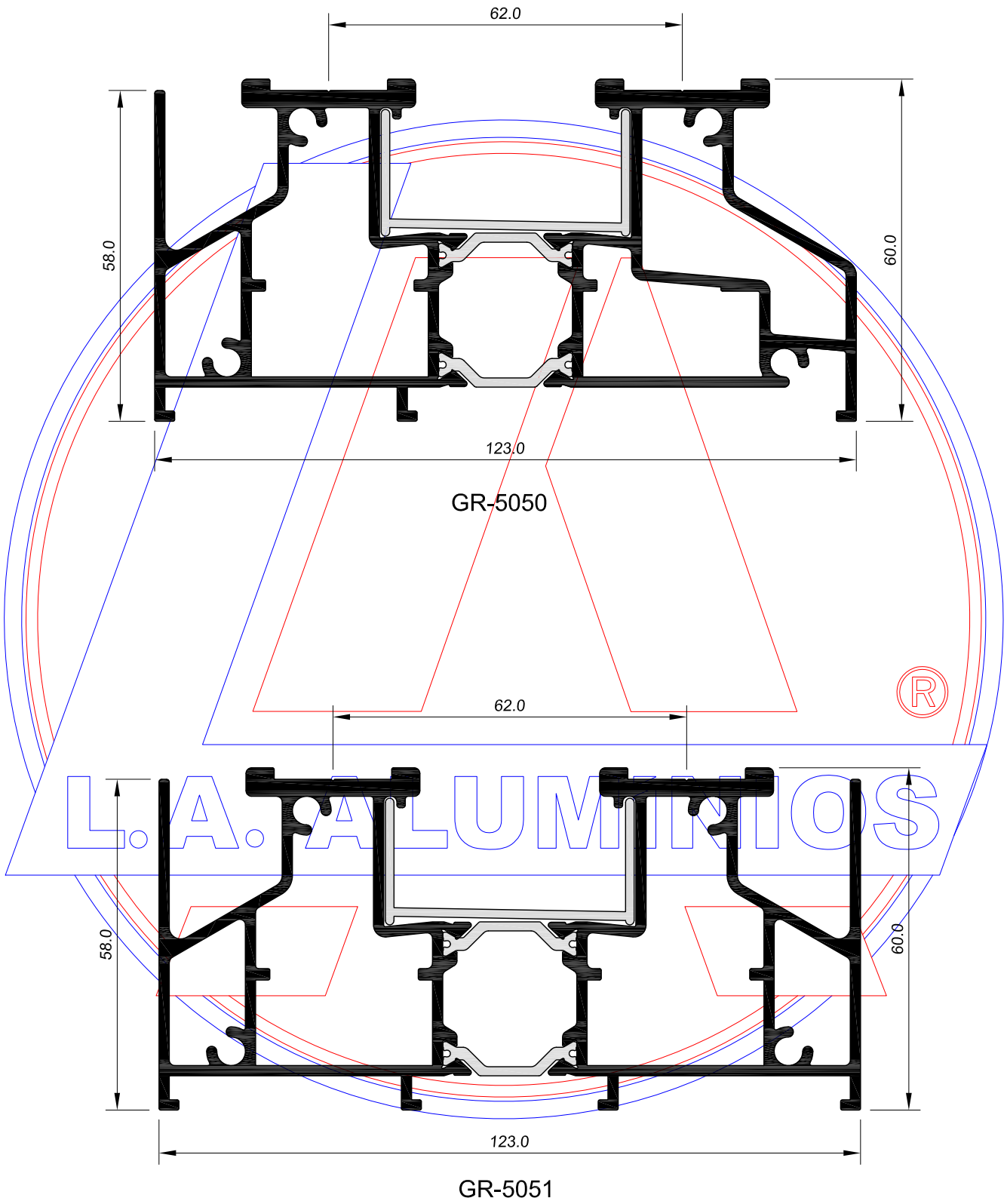

2013.07.15

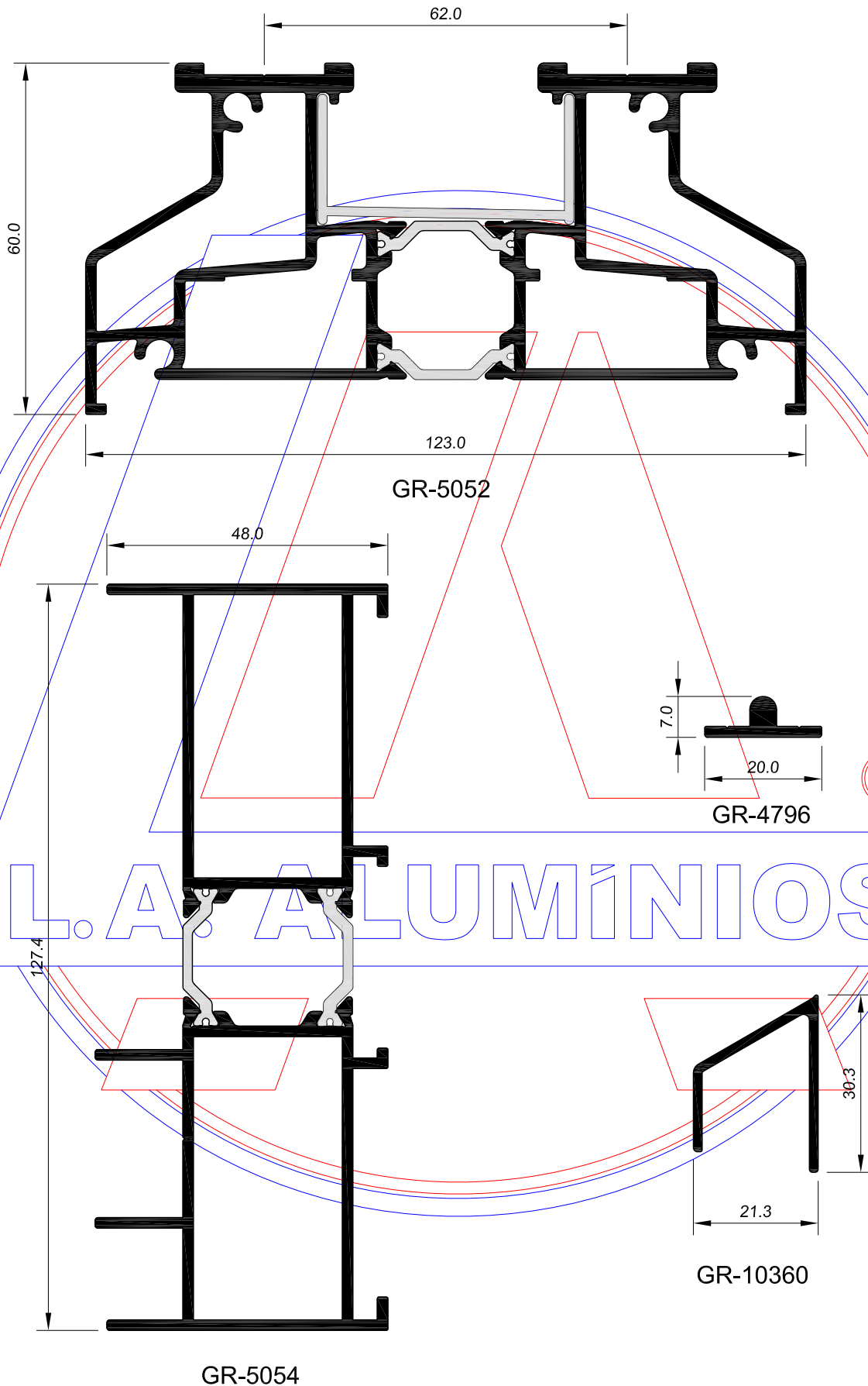

2013.07.15

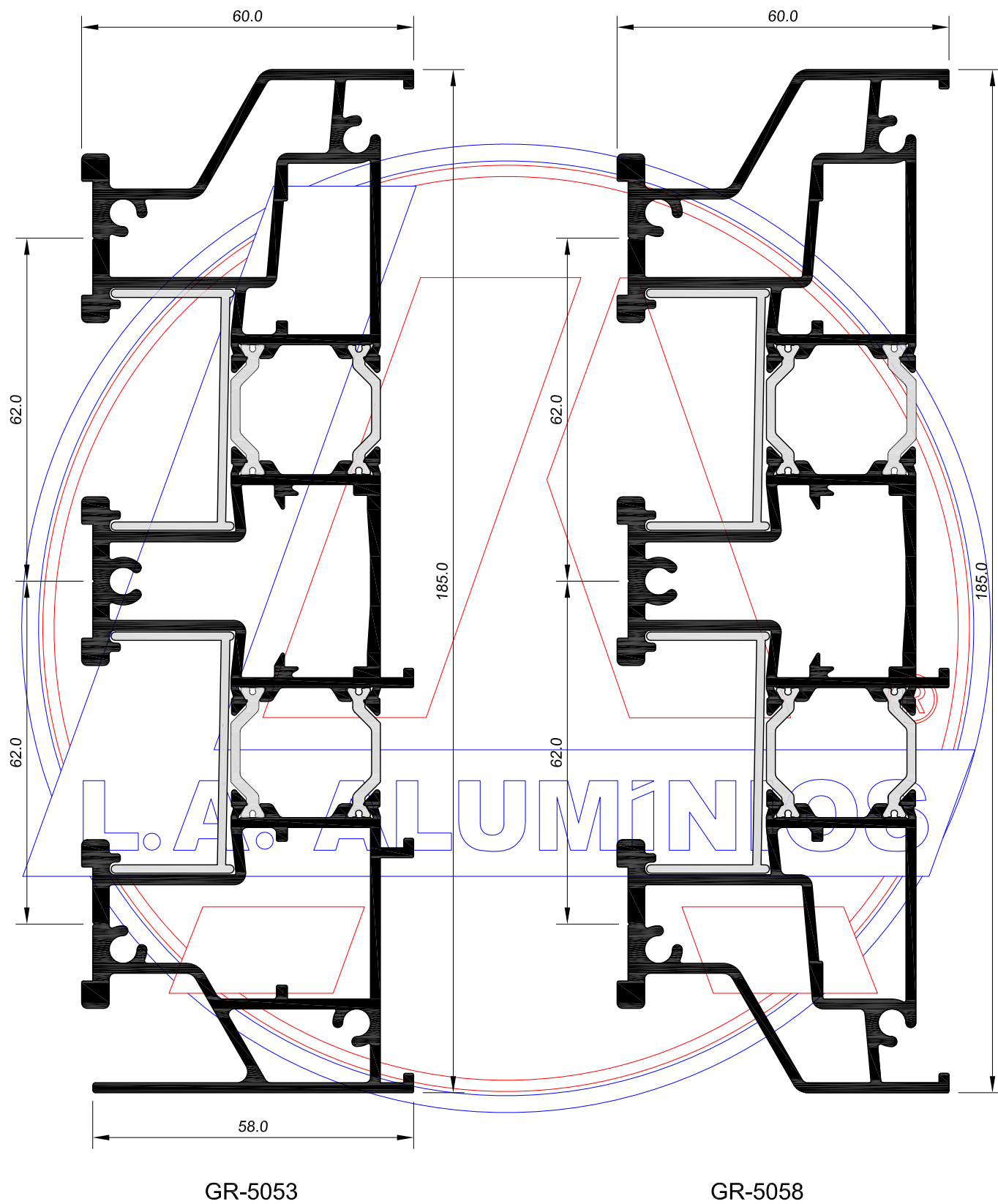

2013.07.15

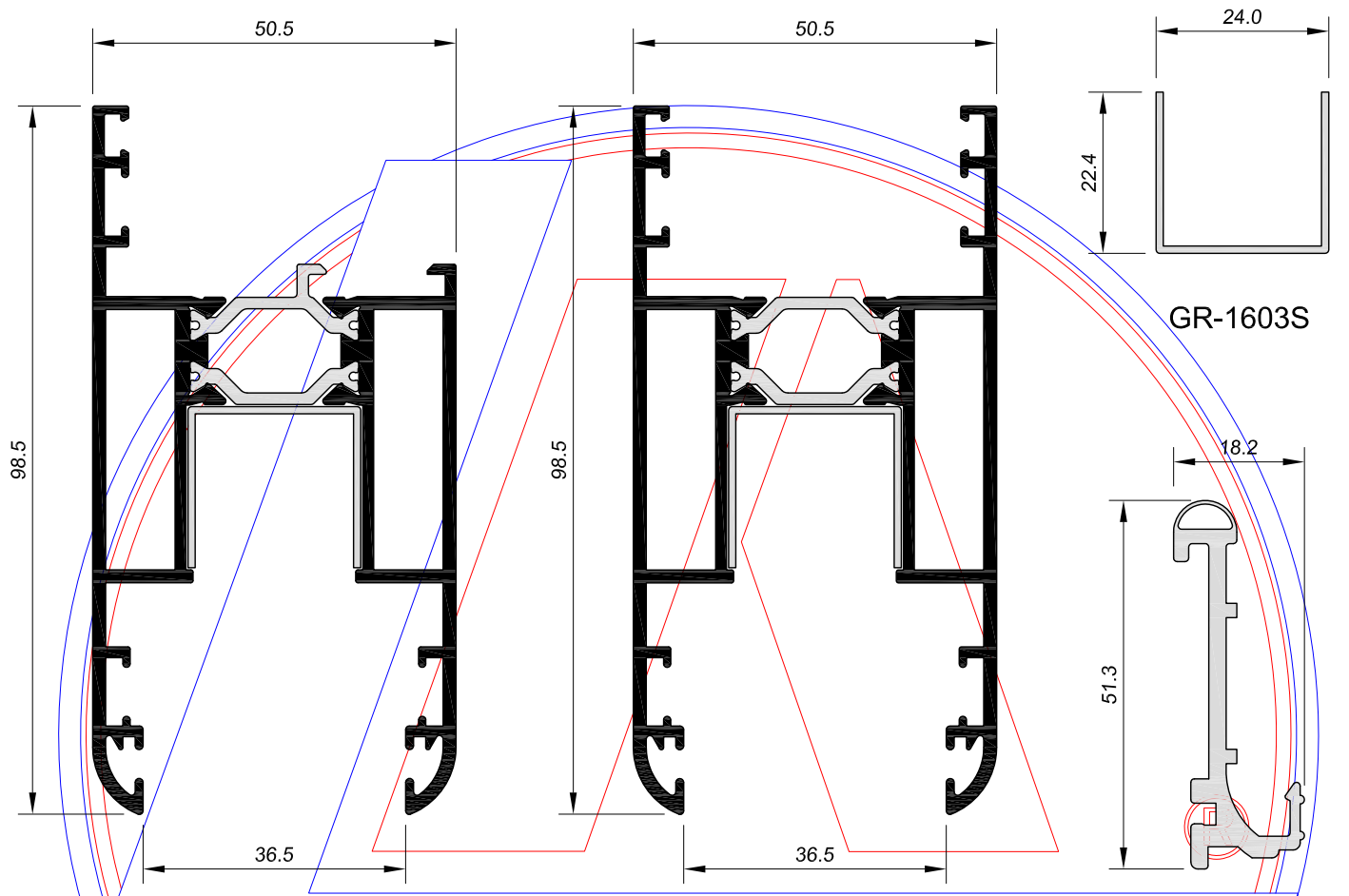

GR-5055

GR-5055A

GR-1603S

L.A. ALUMINIUMS

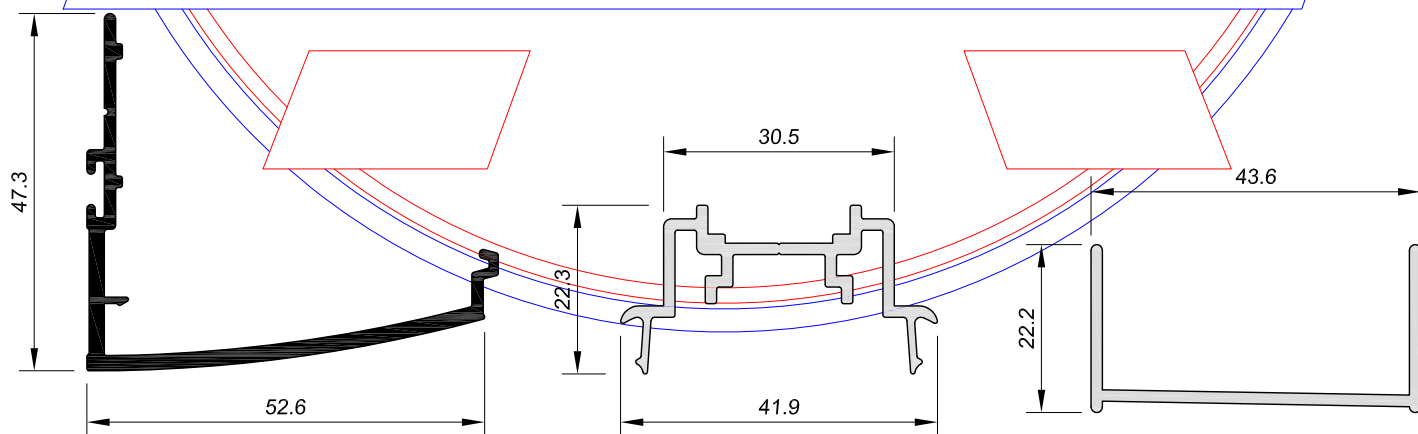

GR-10357

GR-1606S





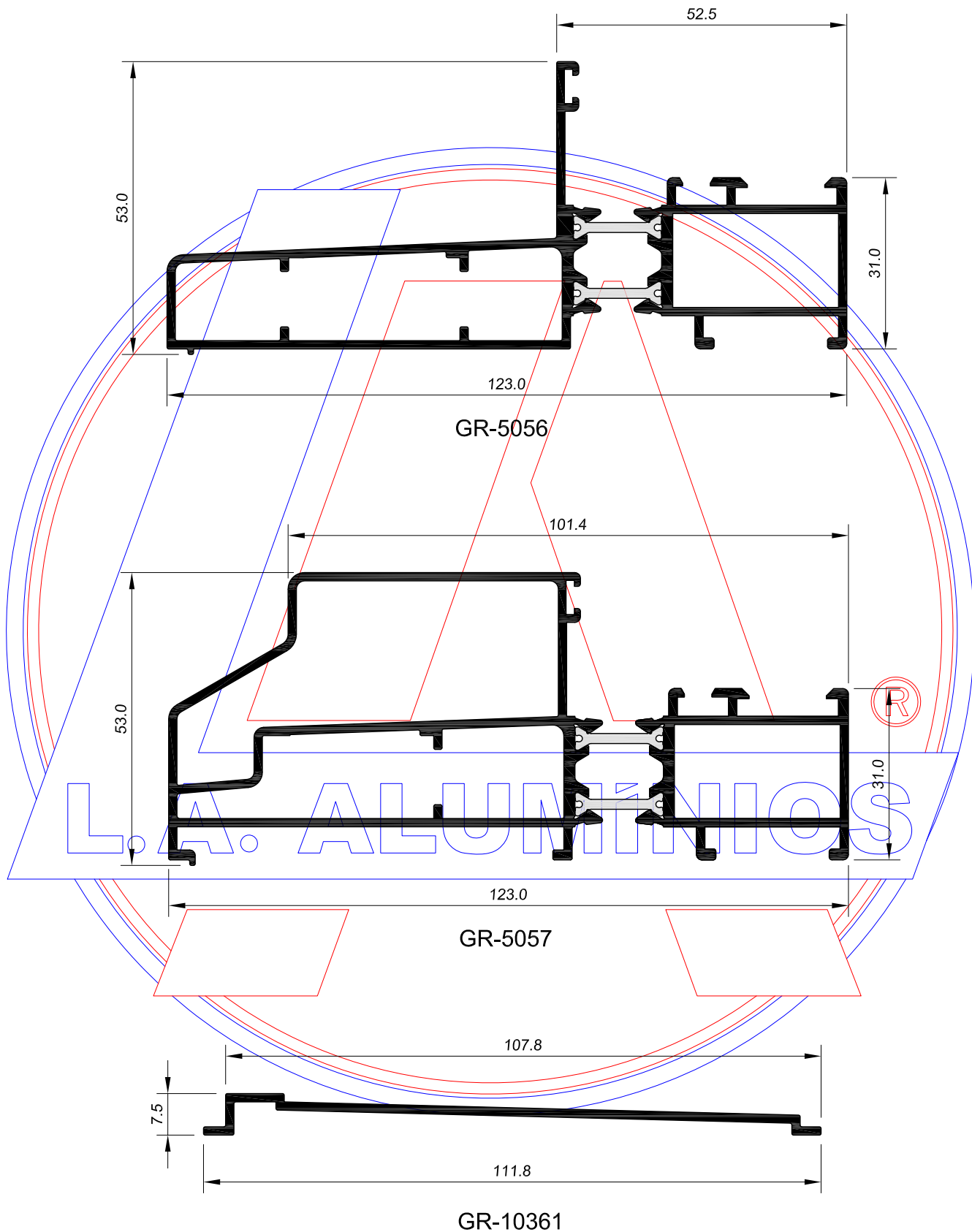











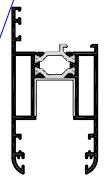

GR-1604S

2013.07.15



2013.07.15

DIMENSÕES DO ESPAÇO PARA REVESTIMENTO

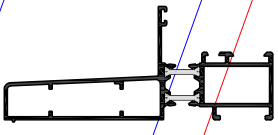
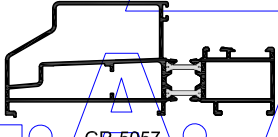
PERFIS	BITES						
		CE-7637	CE-7615	CE-7613	CE-7614	CE-7504	CE-7505
 GR-5055	41,5 mm						
		CE-4284	CE-7634	CE-7525	CE-7530	CE-7724	CE-7498
							
 GR-5056	44,5 mm	32,5 mm	29,5 mm	24,5 mm	20,5 mm	16,5 mm	12,0 mm
		32,5 mm	29,5 mm	24,5 mm	20,5 mm	16,5 mm	12,0 mm
		32,5 mm	29,5 mm	24,5 mm	20,5 mm	15,5 mm	12,0 mm
 GR-5057	44,5 mm	35,5 mm	32,5 mm	27,5 mm	23,5 mm	19,5 mm	15,0 mm
		35,5 mm	32,5 mm	27,5 mm	23,5 mm	19,5 mm	15,0 mm
		35,5 mm	32,5 mm	27,5 mm	23,5 mm	18,5 mm	15,0 mm